



Electrical Characteristics

PARAMETER	SYMBOL	UNIT	TEST CONDITIONS	Typ.	Max.



YJD106540NCTQG2

RoHS
COMPLIANT

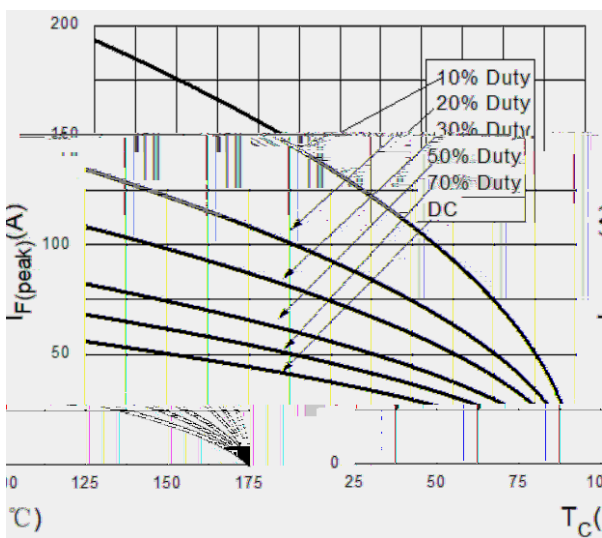
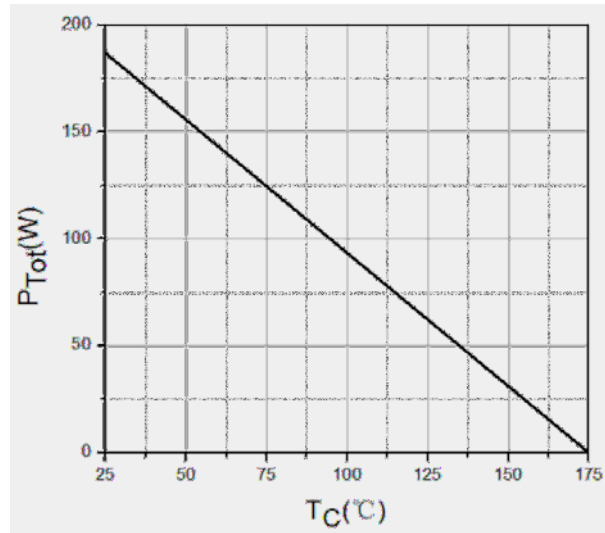
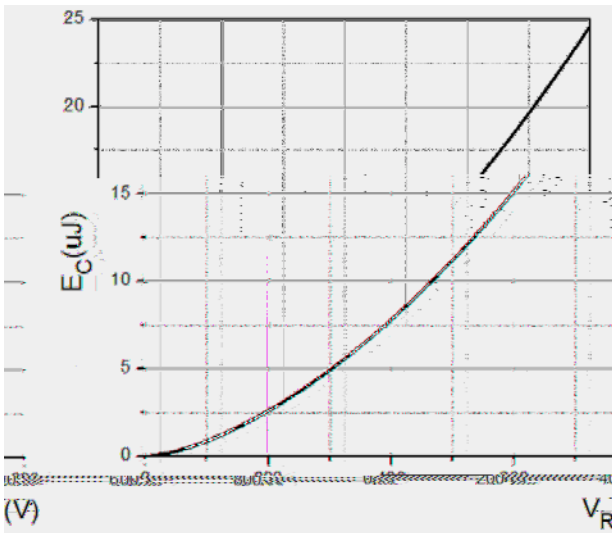
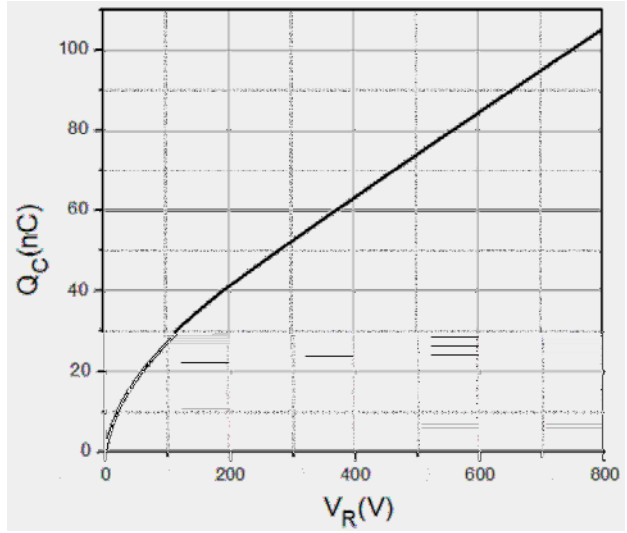
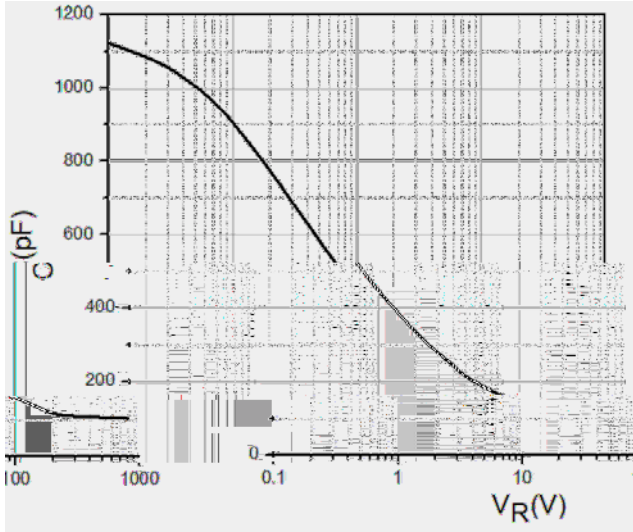



Typical Characteristics

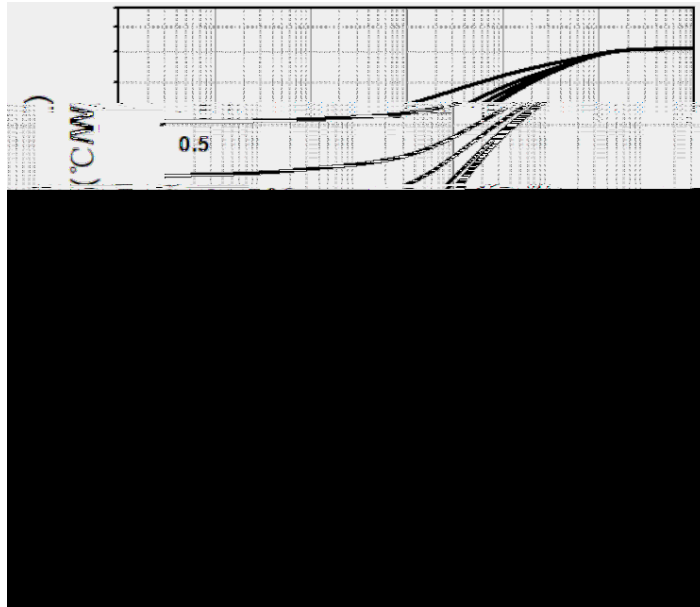



Outline Dimensions

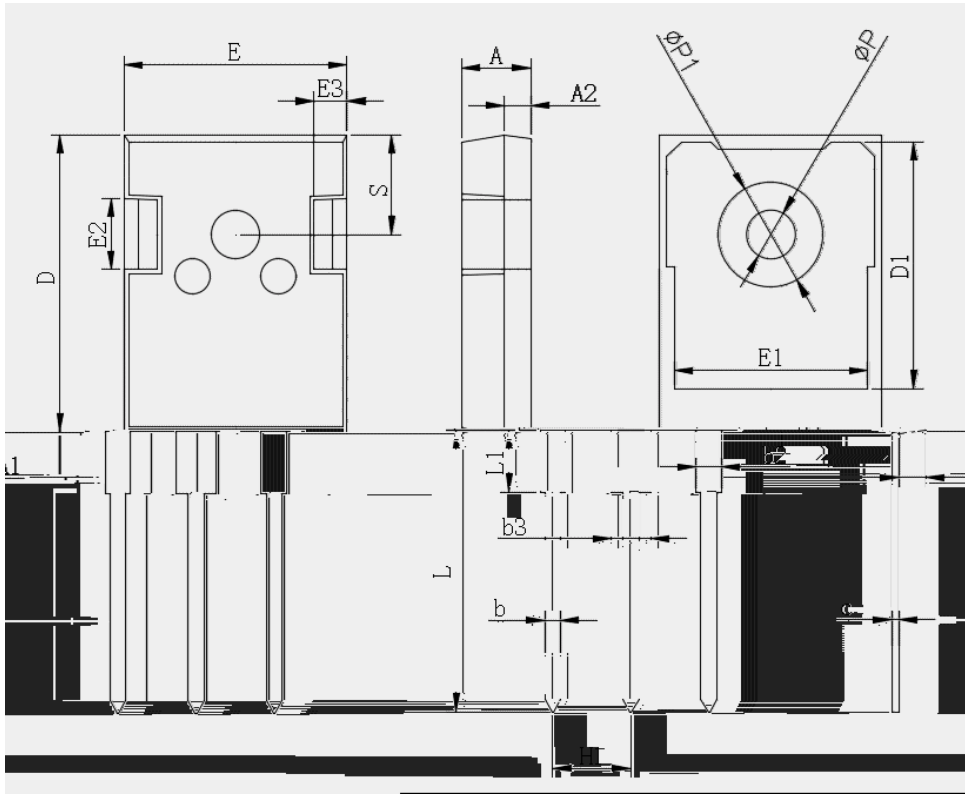

TQ-247AB			
	Max	Dim	Min
3	5.2	A	4.8
21	2.61	A1	2.2
35	2.15	A2	1.8
	1.4	b	1
91	2.21	b2	1.9
5	0.7	C	0.5
7	21.3	D	20
25	16.85	D1	16
5	16.1	E	15
	4.8	E2	5.2
	2.3	E3	2.7
	19.62	L	20.22
	-	L1	4.3
	3.4	ΦP	3.8
		ΦP1	7.3
	6.15TYP	S	
	5.44TYP	H1	



YJD106540NCTQG2

RoHS
COMPLIANT

Disclaimer
