



MG100HF12TLC1

IGBT Modules

V_{CES}	1200V
I_c	100A

Applications

Inverter for motor drive
AC and DC servo drive amplifier
UPS (Uninterruptible Power Supplies)
Soft switching welding machine

Features

Low $V_{ce(sat)}$ with Trench technology
 $V_{ce(sat)}$ with positive temperature coefficient
High short circuit capability(10us)
Including ultra fast & soft recovery anti-parallel FWD
Low inductance
Maximum junction temperature 175

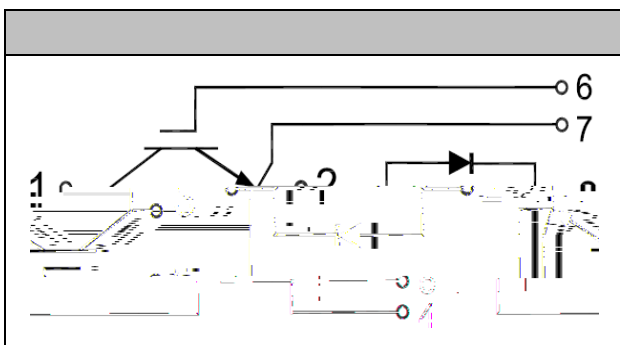

● IGBT

Absolute Maximum Ratings

Parameter	Symbol	Conditions	Value	Unit
Collector-Emitter Voltage	V_{CES}	$V_{GE}=0V, I_c = 1mA, T_{vj}=25$	1200	V
Continuous Collector Current	I_c	$T_c=100$	100	A
Repetitive Peak Collector Current	I_{CRM}	$t_p=1ms$	200	A
Gate-Emitter Voltage	V_{GES}	$T_{vj}=25$	20	V
Total Power Dissipation	P_{tot}	$T_c=25$ $T_{vjmax}=175$	785	W



MG100HF12TLC1



Characteristic values

Parameter	Symbol	Conditions	Value			Unit
			Min.	Typ.	Max.	
Gate-emitter Threshold Voltage	$V_{GE(th)}$	$V_{GE}=V_{CE}, I_C=4mA, T_{vj}=25$	5.0	6.2	7.0	V
Collector-Emitter Cut-off Current	I_{CES}	$V_{CE}=1200V, V_{GE}=0V, T_{vj}=25$			1.0	mA
Collector-Emitter Saturation Voltage	$V_{CE(sat)}$	$I_C=100A, V_{GE}=15V, T_{vj}=25$		1.85		V
		$I_C=100A, V_{GE}=15V, T_{vj}=125$		2.05		
Input Capacitance	C_{ies}	$V_{CE}=25V, V_{GE}=0V,$ $f=1MHz, T_{vj}=25$		7.43		nF
Reverse Transfer Capacitance	C_{res}				0.34	
Gate-Emitter leakage current	I_{GES}					
Turn-on Delay Time	$t_{d(on)}$			279		ns

Rise Time

t_r

61

$I_C = 100 A$

$V_{CE} = 600 V$

$V_{GE} = \pm 15VnF$

$R_G = 5.6$

$T_{vj}=25$



MG100HF12TLC1

● Diode

Absolute Maximum Ratings

Parameter	Symbol	Conditions	Value	Unit
Repetitive Peak Reverse Voltage	V_{RRM}	$T_{vj}=25$	1200	V
Continuous DC Forward Current	I_F		100	A
Repetitive Peak Forward Current	I_{FRM}	$t_p=1\text{ms}$	200	A

Characteristic values

Parameter	Symbol	Conditions	Value			Unit
			Min.	Typ.	Max.	
Forward Voltage	V_F	$I_F=100\text{A}, T_{vj}=25$		1.80		V
		$I_F=100\text{A}, T_{vj}=125$		1.85		
Recovered Charge	Q_{rr}	$I_F=100\text{A}$		11.4		μC
Peak Reverse Recovery Current	I_{rr}	$V_R=600\text{V}$ $-di_F/dt=1900\text{A}/\mu\text{s}$		103		A
Reverse Recovery Energy	E_{rec}	$T_{vj}=25$		5.8		mJ
Recovered Charge	Q_{rr}	$I_F=100\text{A}$		22.5		μC
Peak Reverse Recovery Current	I_{rr}	$V_R=600\text{V}$ $-di_F/dt=1900\text{A}/\mu\text{s}$		140		A
Reverse Recovery Energy	E_{rec}	$T_{vj}=125$		10.6		mJ



MG100HF12TLC1



● Module Characteristics

T_c=25°C unless otherwise specified

Parameter	Symbol	Conditions	Value			Unit
			Min.	Typ.	Max.	
Isolation voltage	V _{isol}	t=1min,f=50Hz	2500			V
Maximum Junction Temperature	T _{jmax}				175	
Operating Junction Temperature	T _{vjop}		-40		150	
Storage Temperature	T _{stg}		-40		125	
Thermal Resistance Junction-to Case	R _{JC}	per IGBT			0.19	K/W
		per Diode			0.29	
Thermal Resistance Case-to Sink	R _{CS}	Conductive grease applied		0.05		K/W
Module Electrodes Torque	M _t	Recommended(M5)	2.5		5.0	N·m
Module-to-Sink Torque	M _s	Recommended(M6)	3.0		5.0	N·m
Weight of Module	G			150		g



MG100HF12TLC1

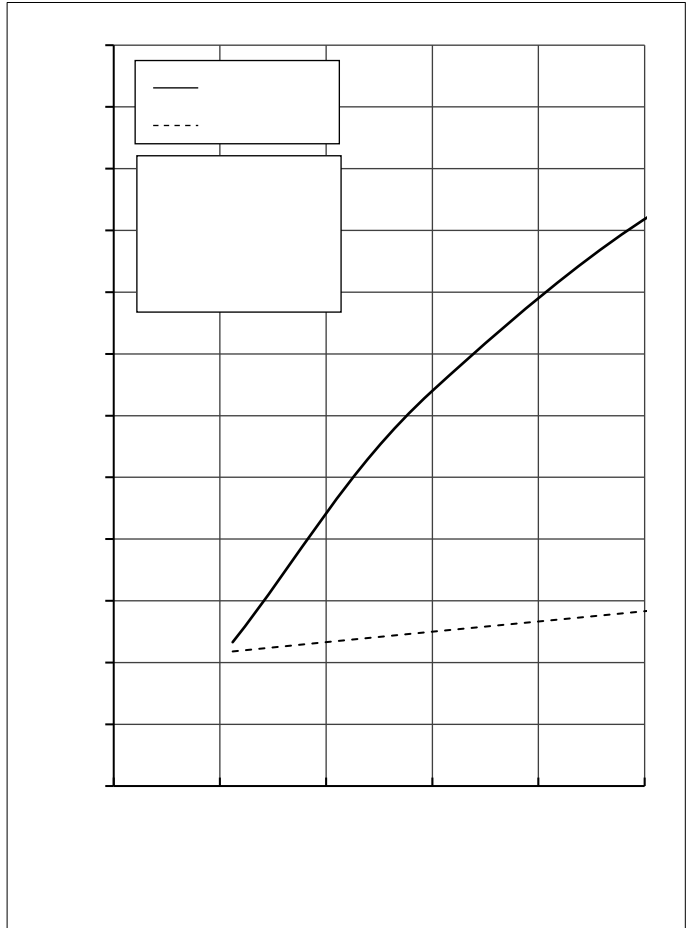
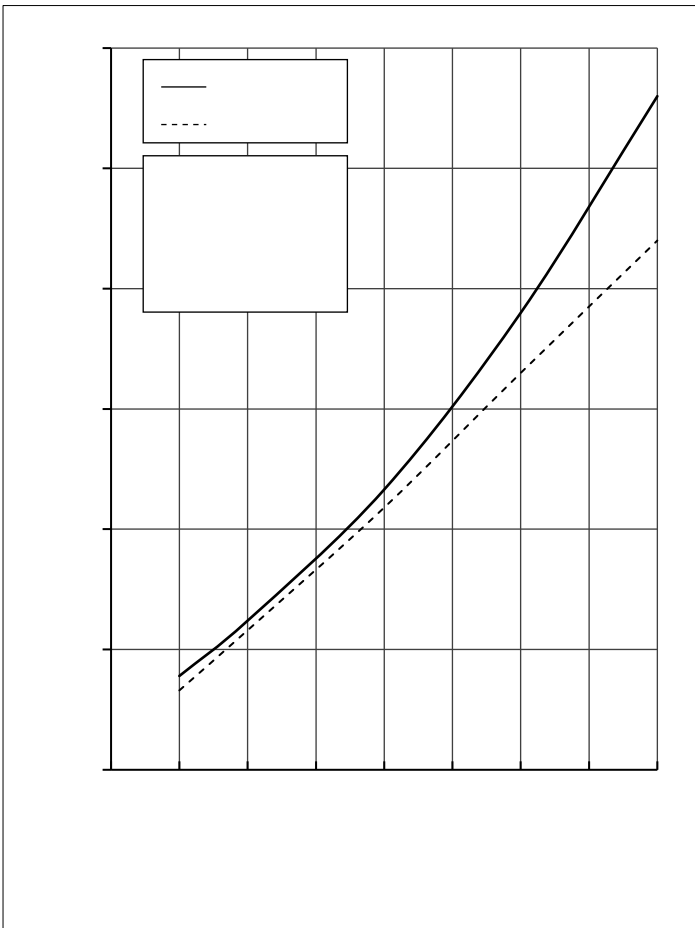
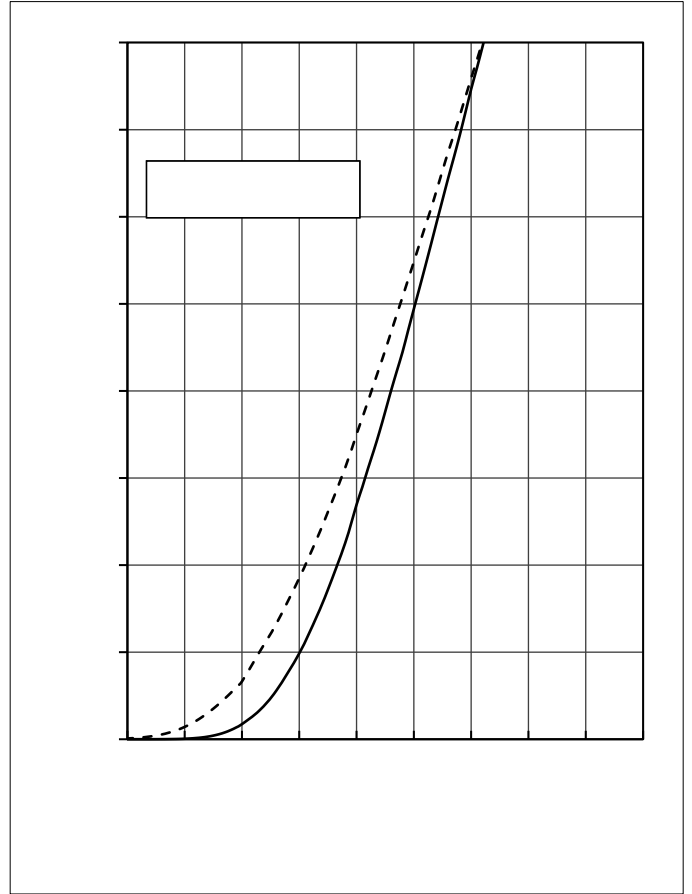
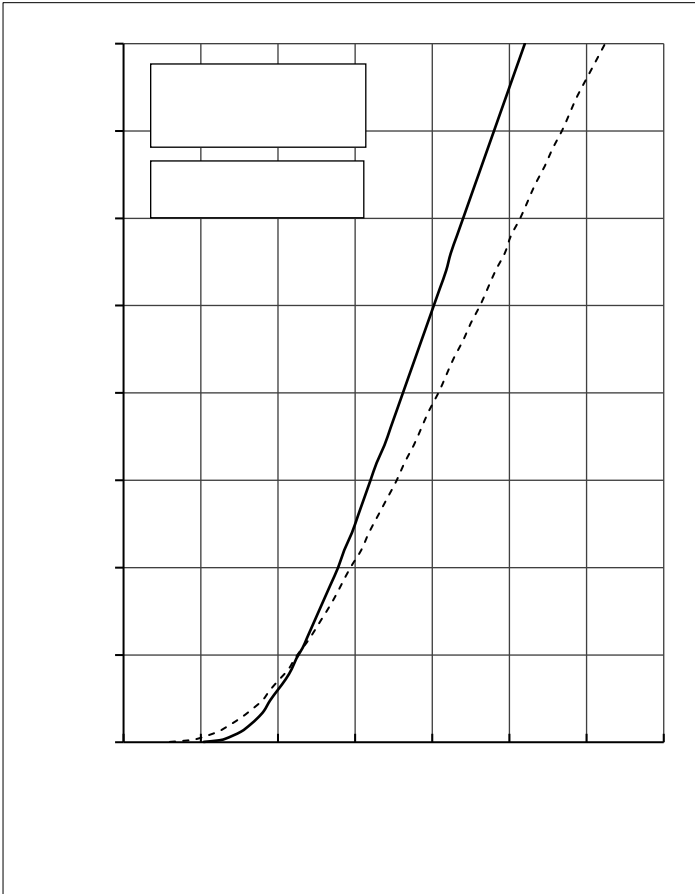



MG100HF12TLC1

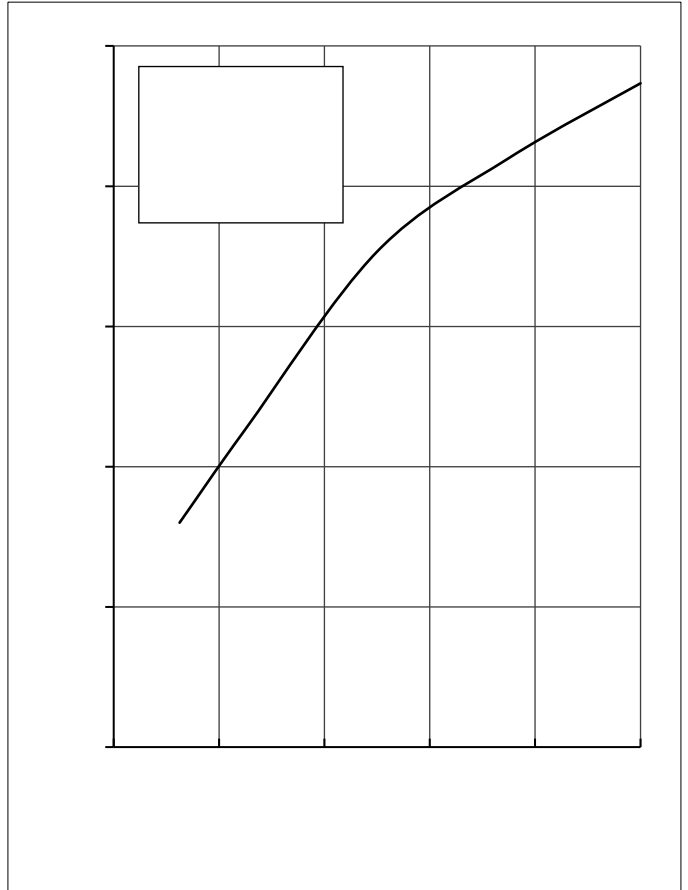
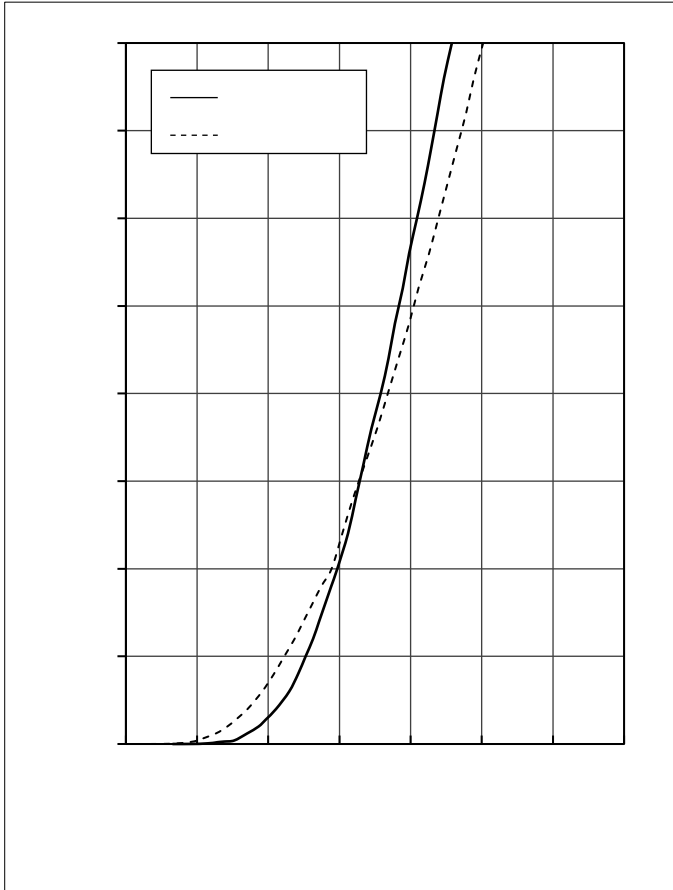
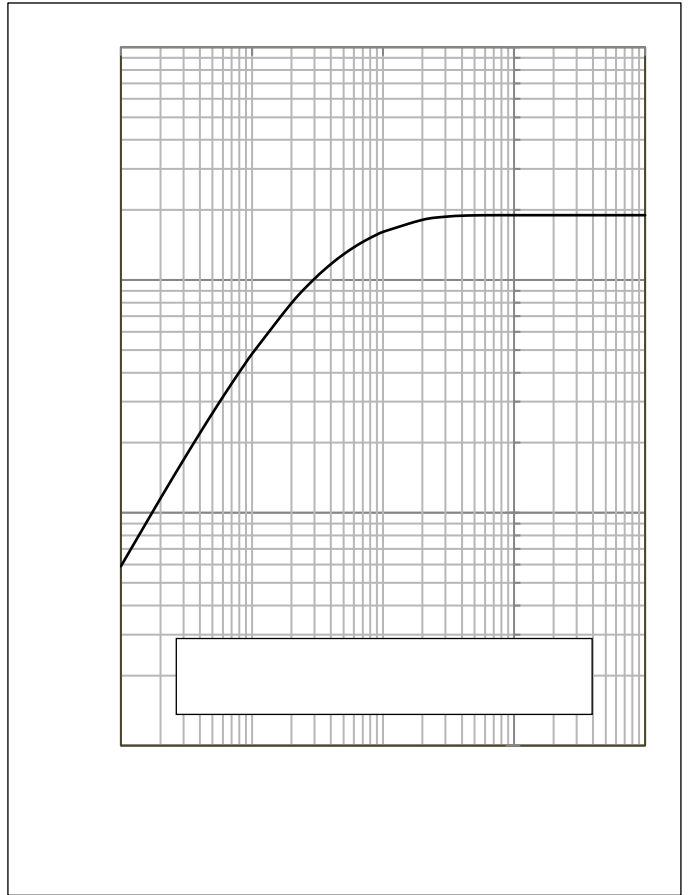
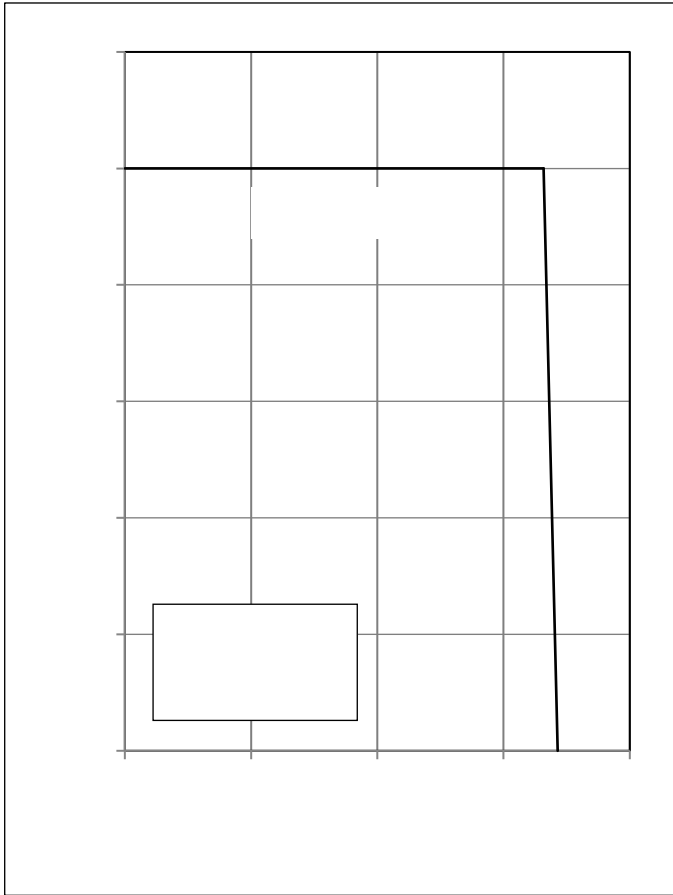



MG100HF12TLC1

● Circuit Diagram

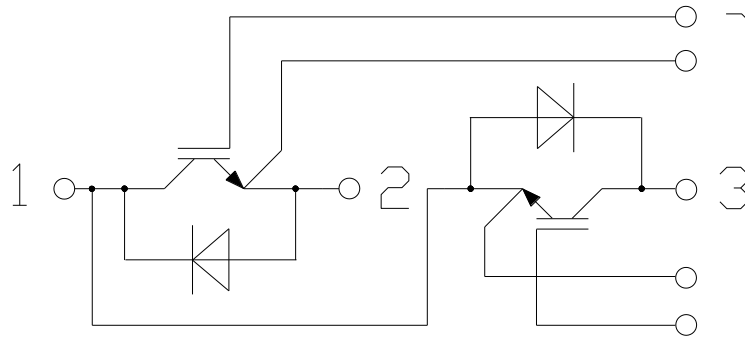

● Package Outline Information

Dimensions in Millimeters

