



# MG50HF12TLC1



## IGBT Modules

V <sub>CES</sub>	1200V
I <sub>C</sub>	50A

## Applications

- Inverter for motor drive
- AC and DC servo drive amplifier
- UPS (Uninterruptible Power Supplies)
- Soft switching welding machine

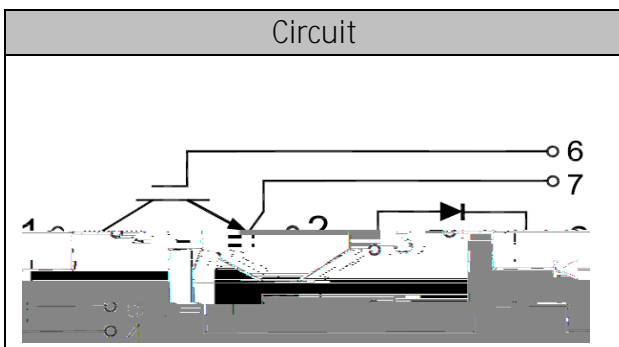

## Features

- Low V<sub>ce(sat)</sub> with Trench technology
- V<sub>ce(sat)</sub> with positive temperature coefficient
- High short circuit capability(10us)
- Including ultra fast & soft recovery anti-parallel FWD
- Low inductance
- Maximum junction temperature 175

## ● IGBT

### Absolute Maximum Ratings

Parameter	Symbol	Conditions	Value	Unit
Collector-Emitter Voltage	V <sub>CES</sub>	V <sub>GE</sub> =0V, I <sub>C</sub> =1mA, T <sub>vj</sub> =25	1200	V
Continuous Collector Current	I <sub>C</sub>	T <sub>c</sub> =100	50	A
Repetitive Peak Collector Current	I <sub>CRM</sub>	t <sub>p</sub> =1ms	100	A
Gate-Emitter Voltage	V <sub>GES</sub>	T <sub>vj</sub> =25	20	V
Total Power Dissipation	P <sub>tot</sub>	T <sub>c</sub> =25 T <sub>vjmax</sub> =175	485	W

# MG50HF12TLC1

## Characteristic values

Parameter	Symbol	Conditions	Value			Unit
			Min.	Typ.	Max.	
Gate-emitter Threshold Voltage	$V_{GE(th)}$	$V_{GE}=V_{CE}, I_C=3mA, T_{vj}=25$	5.0	6.2	7.0	V
Collector-Emitter Cut-off Current	$I_{CES}$	$V_{CE}=1200V, V_{GE}=0V, T_{vj}=25$			1.0	mA
Collector-Emitter Saturation Voltage	$V_{CE(sat)}$	$I_C=50A, V_{GE}=15V, T_{vj}=25$		1.85		V
		$I_C=50A, V_{GE}=15V, T_{vj}=125$		2.05		
Input Capacitance	$C_{ies}$	$V_{CE}=25V, V_{GE}=0V,$ $f=1MHz, T_{vj}=25$		4.29		nF
Reverse Transfer Capacitance	$C_{res}$				0.20	
Gate-Emitter leakage current	$I_{GES}$	$V_{CE}=0V, V_{GE}=20V, T_{vj}=25$			400	nA
Turn-on Delay Time	$t_{d(on)}$			150		ns
Rise Time	$t_r$			75		ns

$I_C=50A$   
 $V_{CE}=600V$   
 $V_{GE}=\pm 15V$   
 $R_G=15$   
 $T_{vj}=25$

# MG50HF12TLC1

## ● Diode

### Absolute Maximum Ratings

Parameter	Symbol	Conditions	Value	Unit
Repetitive Peak Reverse Voltage	$V_{RRM}$	$T_{vj}=25$	1200	V
Continuous DC Forward Current	$I_F$		50	A
Repetitive Peak Forward Current	$I_{FRM}$	$t_p=1\text{ms}$	100	A

### Characteristic values

Parameter	Symbol	Conditions	Value			Unit
			Min.	Typ.	Max.	
Forward Voltage	$V_F$	$I_F=50\text{A}, T_{vj}=25$		1.95	2.20	V
		$I_F=50\text{A}, T_{vj}=125$		2.05		
Recovered Charge	$Q_{rr}$	$I_F=50\text{A}$		2.77		$\mu\text{C}$
Peak Reverse Recovery Current	$I_{rr}$	$V_R=600\text{V}$ $-di_F/dt=800\text{A}/\mu\text{s}$		30		A
Reverse Recovery Energy	$E_{rec}$	$T_{vj}=25$		0.65		mJ
Recovered Charge	$Q_{rr}$	$I_F=50\text{A}$		6.39		$\mu\text{C}$
Peak Reverse Recovery Current	$I_{rr}$	$V_R=600\text{V}$ $-di_F/dt=800\text{A}/\mu\text{s}$		31		A
Reverse Recovery Energy	$E_{rec}$	$T_{vj}=125$		2.16		mJ

# MG50HF12TLC1

## ● Module Characteristics

$T_C=25^{\circ}\text{C}$  unless otherwise specified

Parameter	Symbol	Conditions	Value			Unit
			Min.	Typ.	Max.	
Isolation voltage	$V_{\text{isol}}$	$t=1\text{min}, f=50\text{Hz}$	2500			V
Maximum Junction Temperature	$T_{\text{jmax}}$				175	
Operating Junction Temperature	$T_{\text{vjop}}$		-40		150	
Storage Temperature	$T_{\text{stg}}$		-40		125	
Thermal Resistance Junction-to Case	$R_{\text{JC}}$	per IGBT			0.31	K/W
		per Diode			0.57	
Thermal Resistance Case-to Sink	$R_{\text{CS}}$	Conductive grease applied		0.05		K/W
Module Electrodes Torque	$M_t$	Recommended(M5)	2.5		5.0	N·m
Module-to-Sink Torque	$M_s$	Recommended(M6)	3.0		5.0	N·m
Weight of Module	G			150		g



# MG50HF12TLC1

---

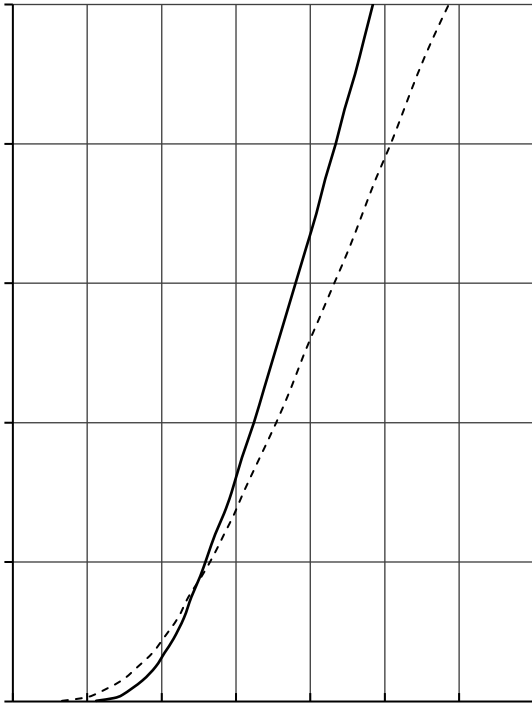



# MG50HF12TLC1

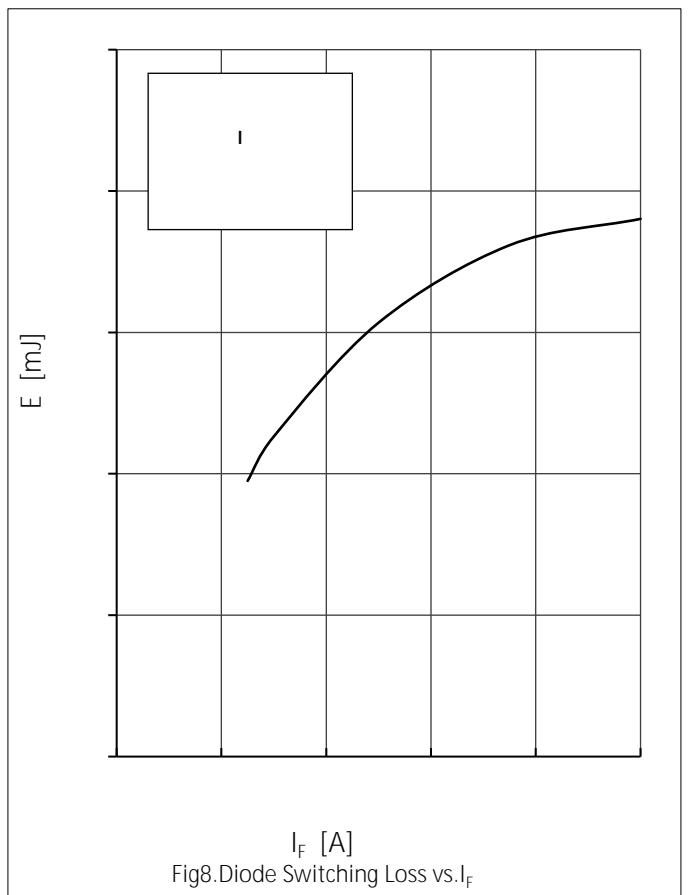
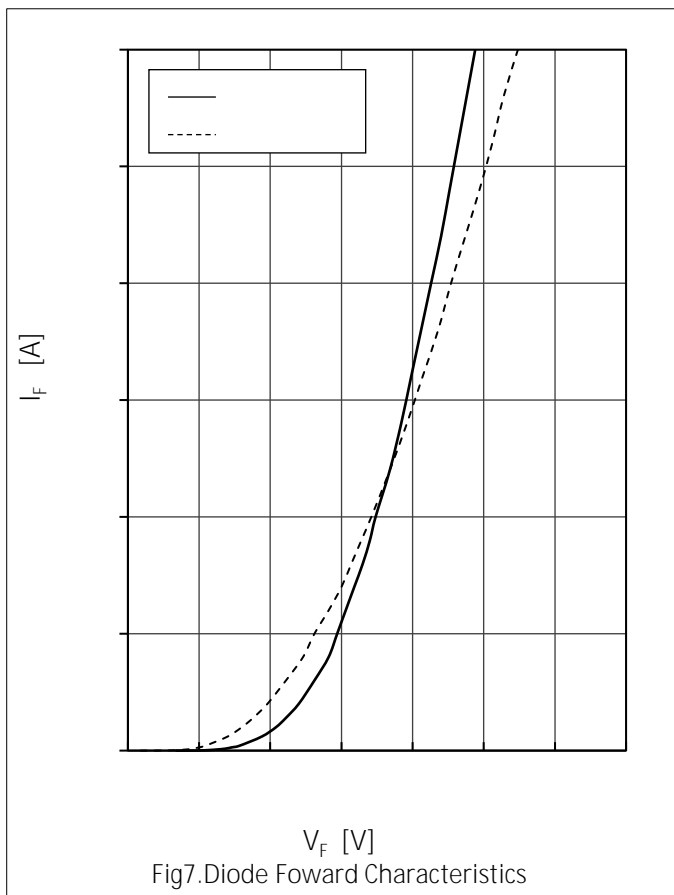
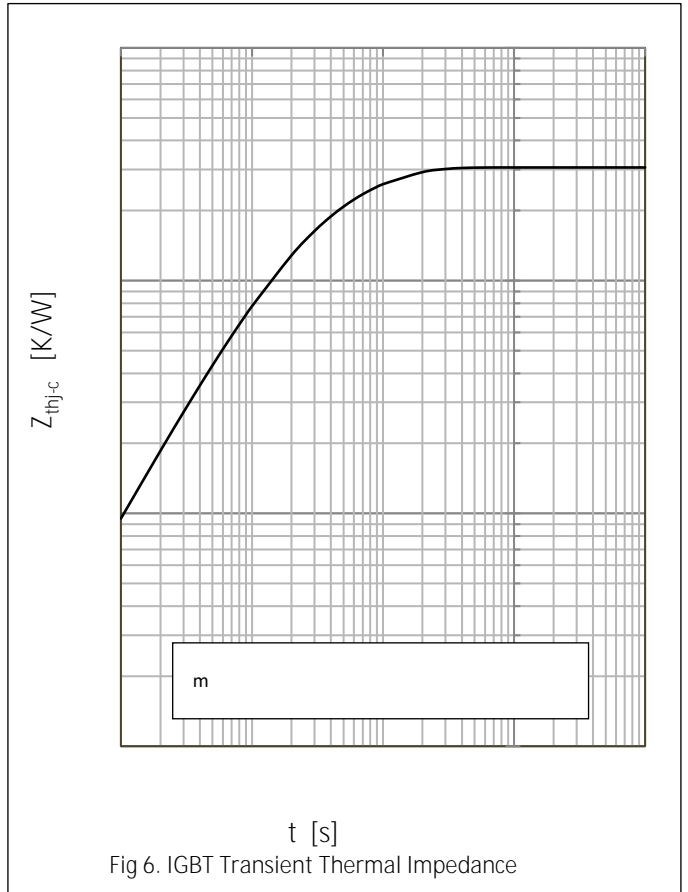
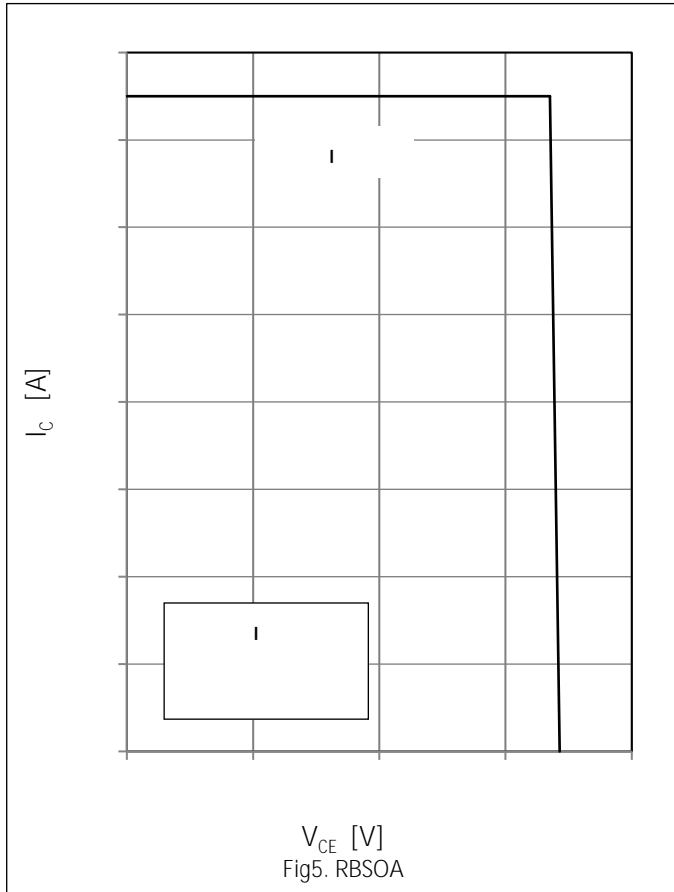



# MG50HF12TLC1

---



# MG50HF12TLC1

## ● Circuit Diagram

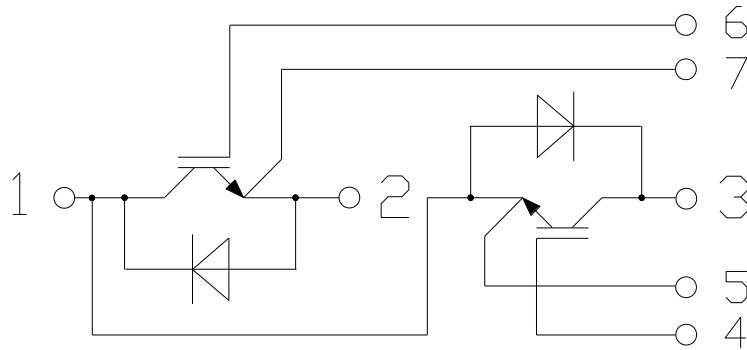

## ● Package Outline Information

Dimensions in Millimeters

