

Electrical Characteristics ○

Off Characteristics						
△		○				○
△						
		○				
On Characteristics						
Dynamic Characteristics						
Switching Characteristics						
Drain-Source Diode Characteristics and Maximum Ratings						

、
、
、
、
、
、

○ ○
○

On-Regin Characteristics

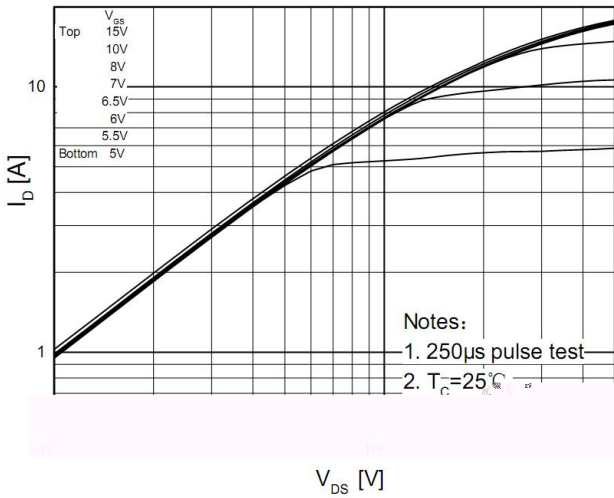

Transfer Characteristics

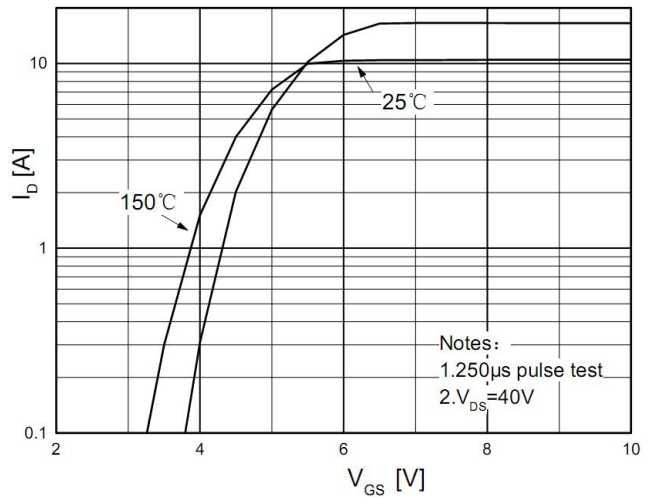

On-Resistance Variation vs. Drain Current and Gate Voltage

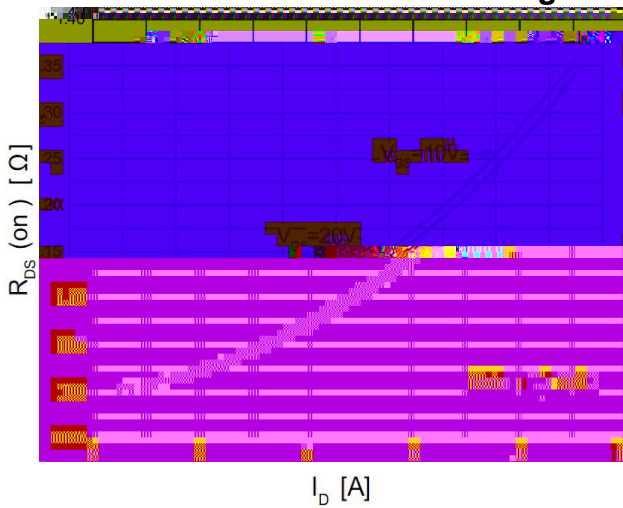

Body Diode Forward Voltage Variation vs. Source Current and Temperature

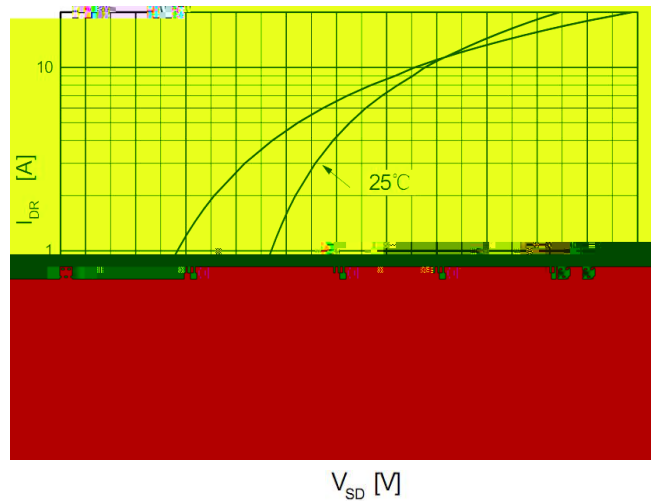

Capacitance Characteristics

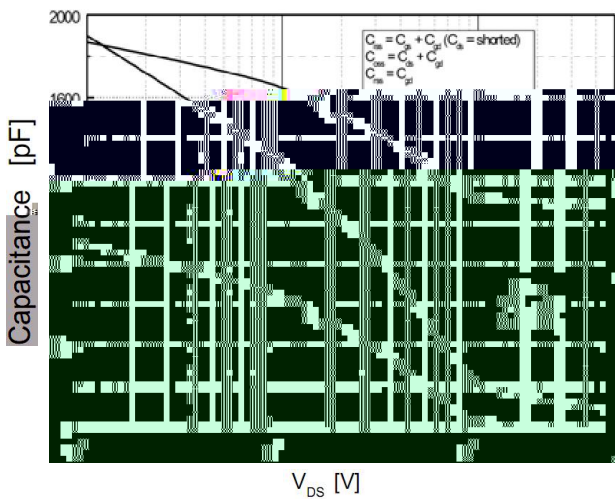

Gate Charge Characteristics

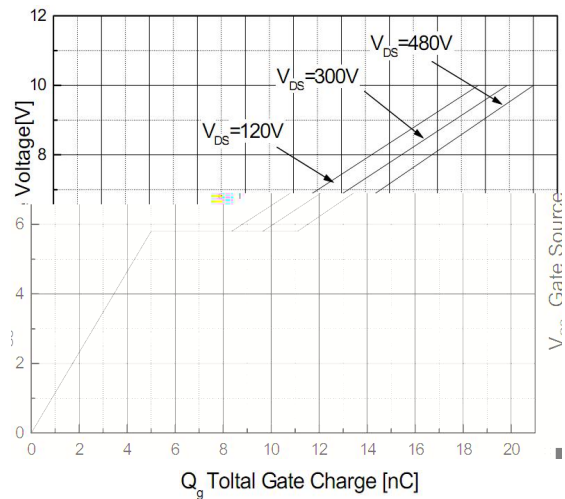

Breakdown Voltage Variation vs. Temperature

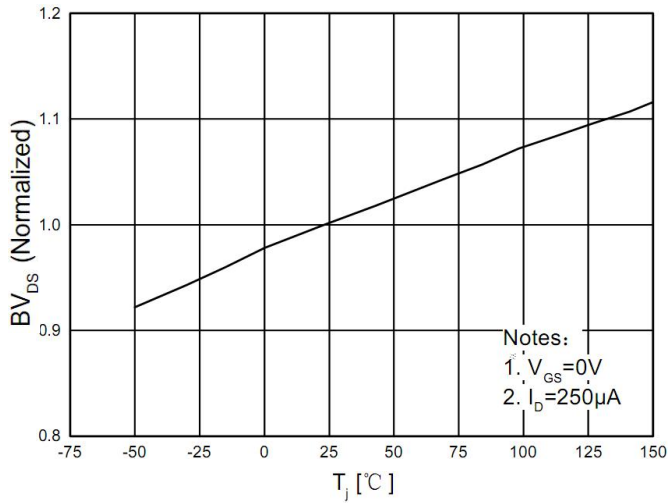

On-Resistance Variation vs. Temperature

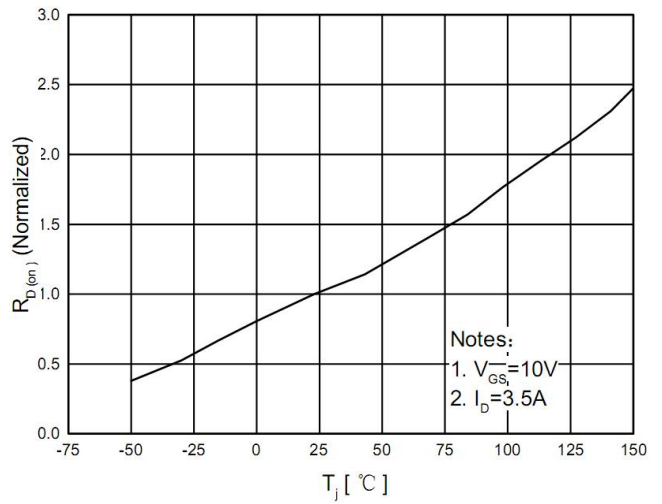

Maximum Safe Operating Area

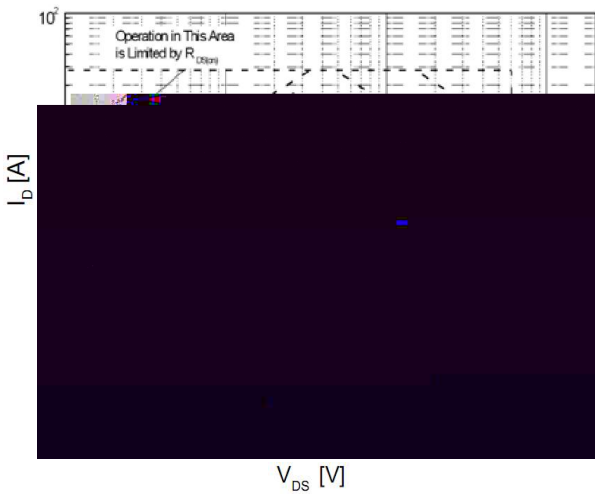

Maximum Drain Current Vs. Case Temperature

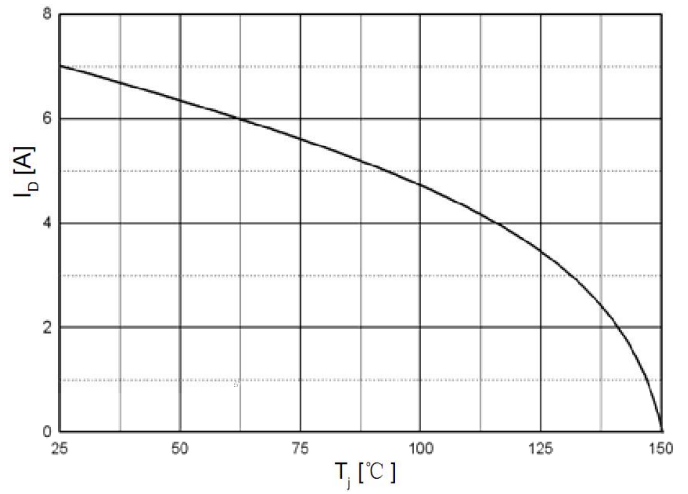

TO-220F Package Dimensions

:

× °

$\frac{H}{9} \%$

H

