







F 3225 K 471 G2

FRX®

4032

贴片尺寸:

SMD Size:

3225 \approx 8.2 \times 6.3mm

4032 \approx 11.0 \times 8.2mm

压敏电压公差: $\pm 10\%$

Varistor voltage

tolerance: $\pm 10\%$

15寸料盘卷装:

15" Reel packing:

3225: 1820PCS/reel

4032: 1500PCS/reel

压敏电压 (V_{1mA}): $47 \times 10^1 = 470V$

Varistor voltage (V_{1mA}): $47 \times 10^1 = 470V$

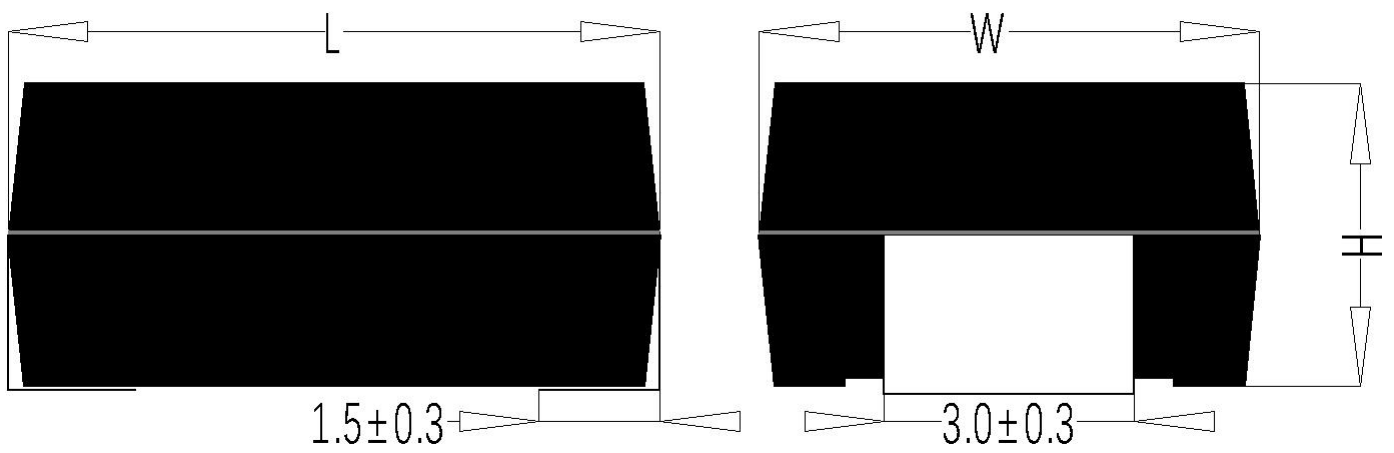



‰

↓





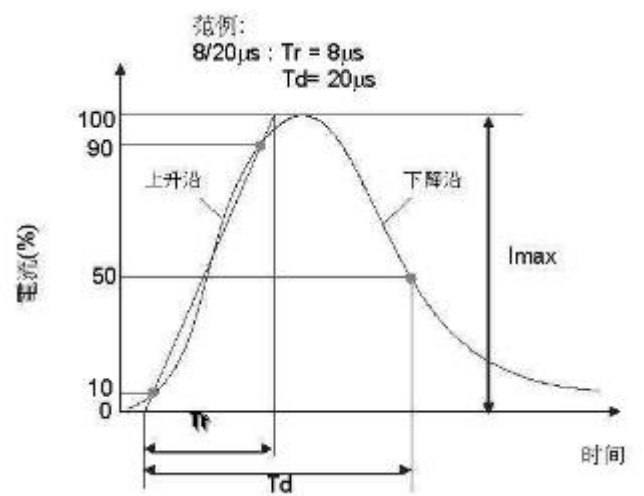
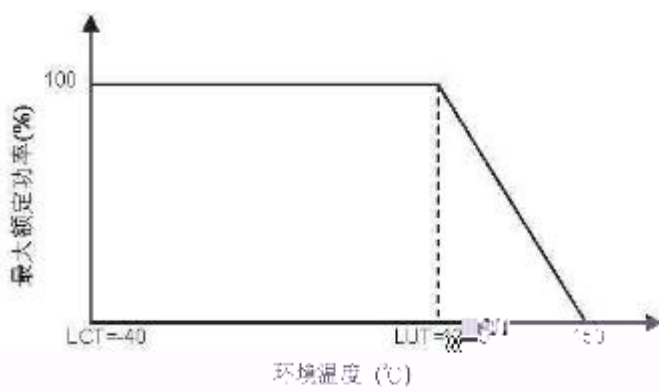



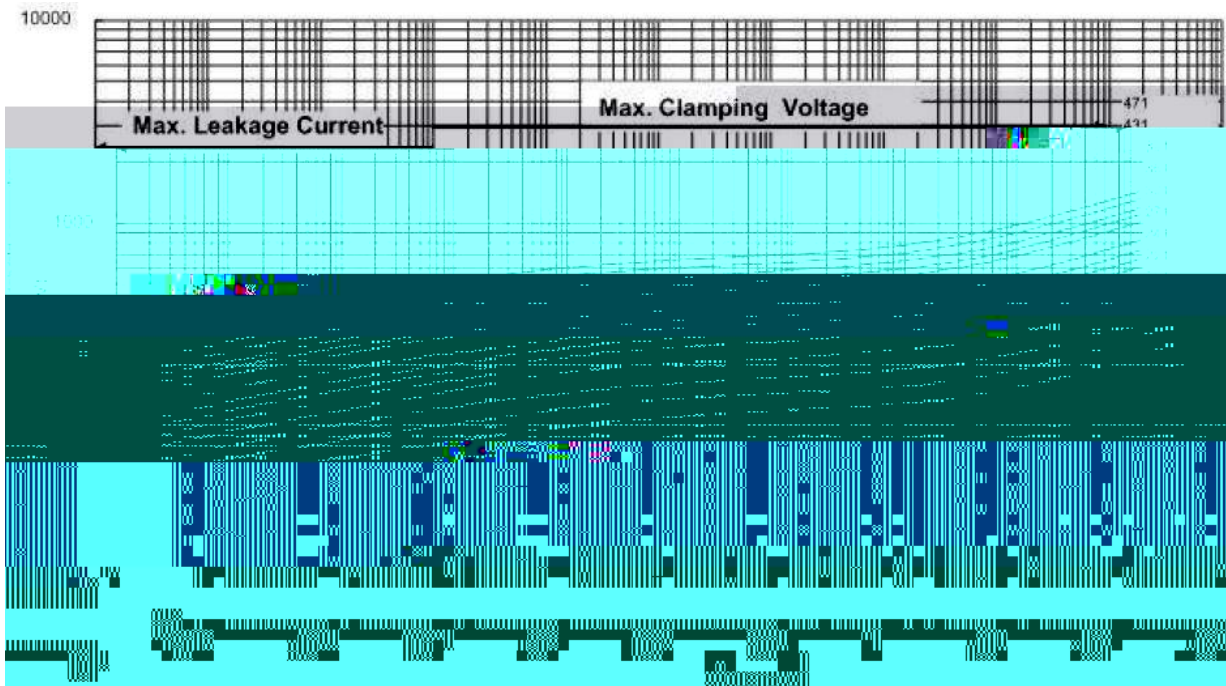
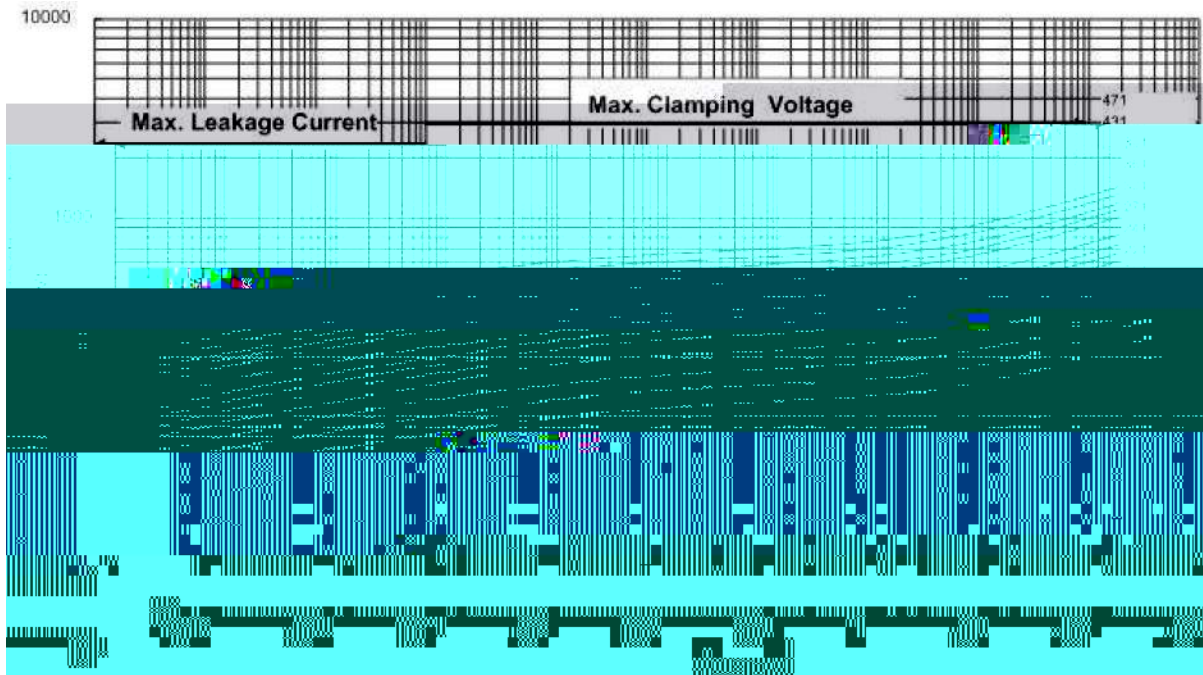

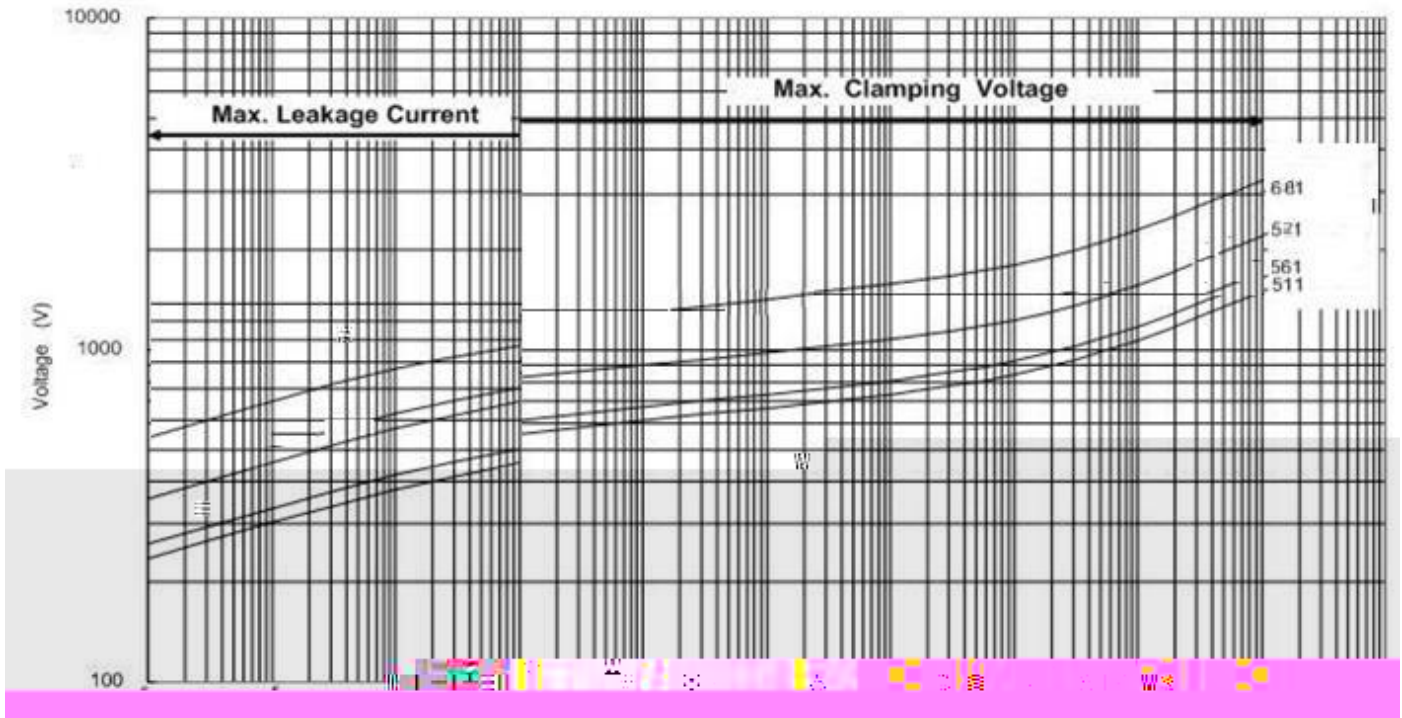

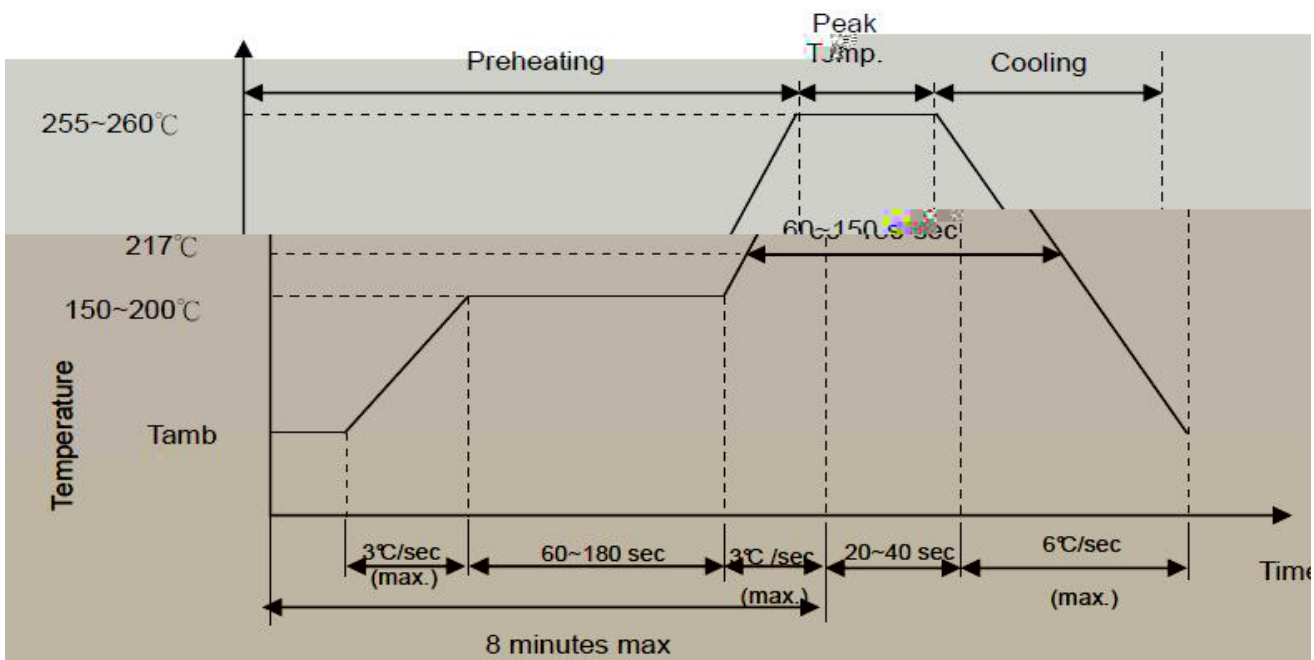
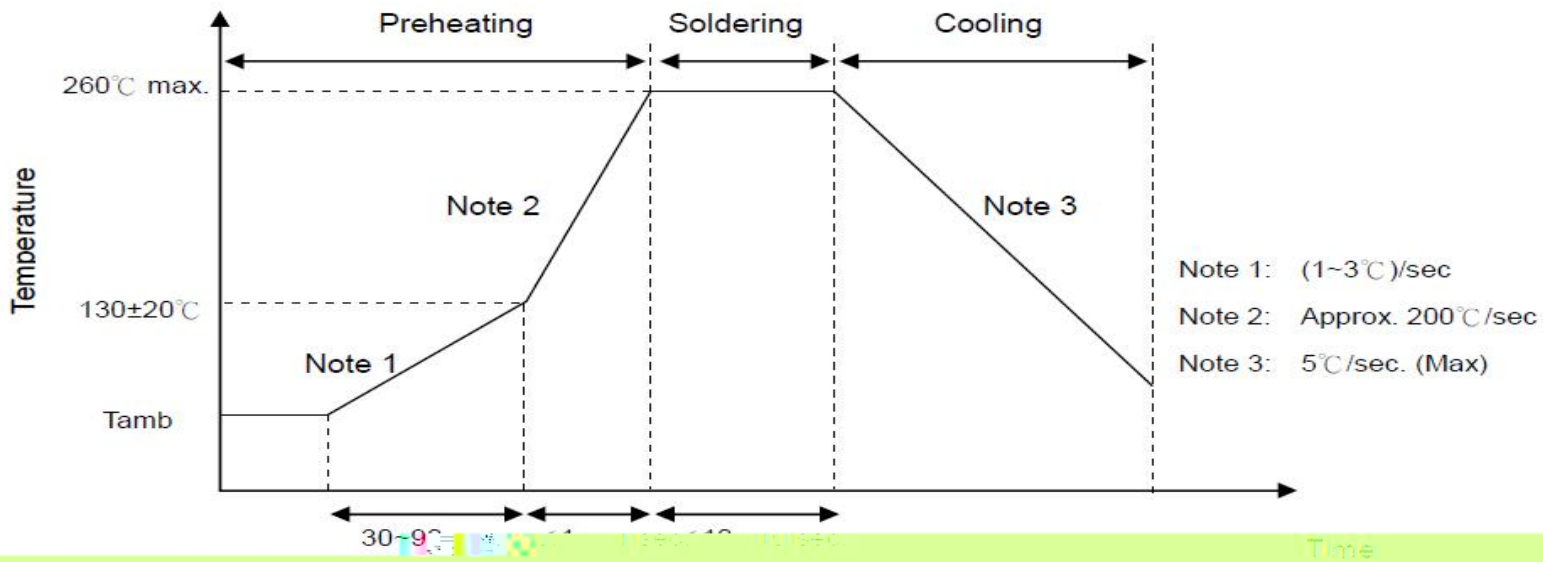

		<table border="1"><tbody><tr><td></td><td></td><td></td></tr><tr><td></td><td></td><td></td></tr><tr><td></td><td></td><td></td></tr><tr><td></td><td></td><td></td></tr><tr><td></td><td></td><td></td></tr></tbody></table>																
		<hr/>																



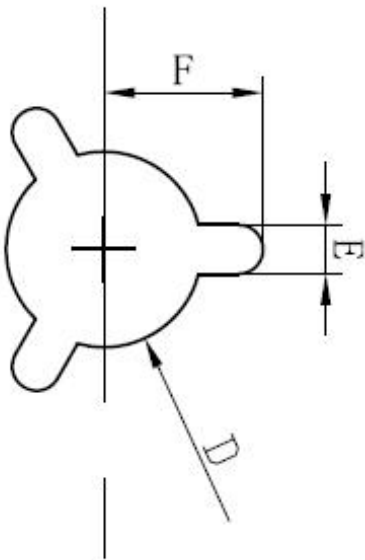
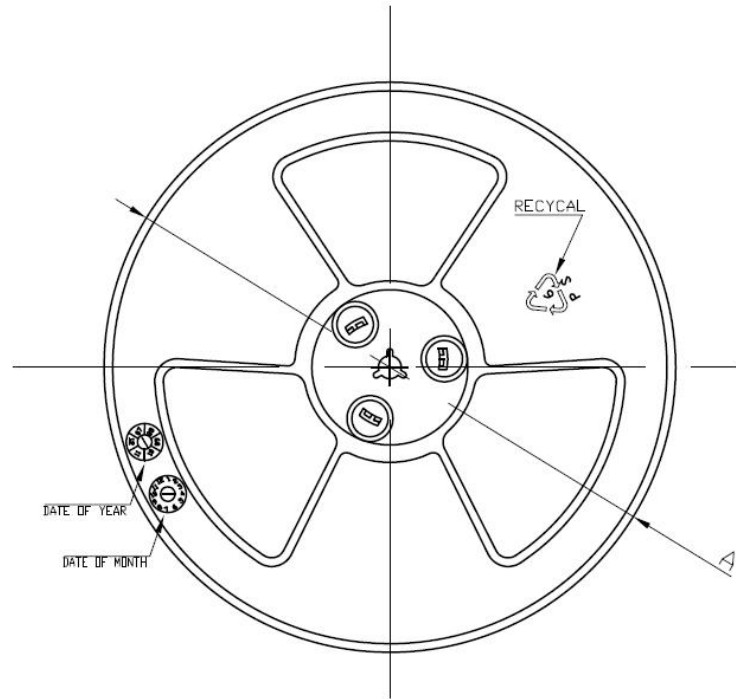

(

