

## 一级代理商：

深圳市弗瑞鑫电子有限公司

地址：深圳市宝安区西乡大道302号金源商务大厦B座三楼

frxelec

%"

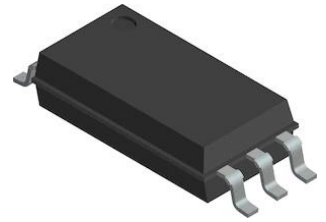

&"

"

("

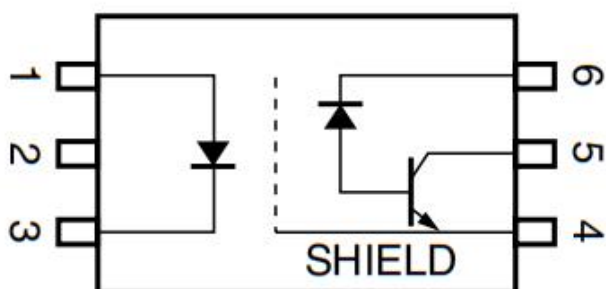

1. Anode
2. NC
3. Cathode
4. GND
5. V<sub>o</sub>
6. V<sub>cc</sub>



\* II

+

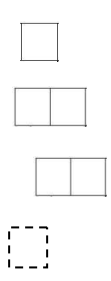
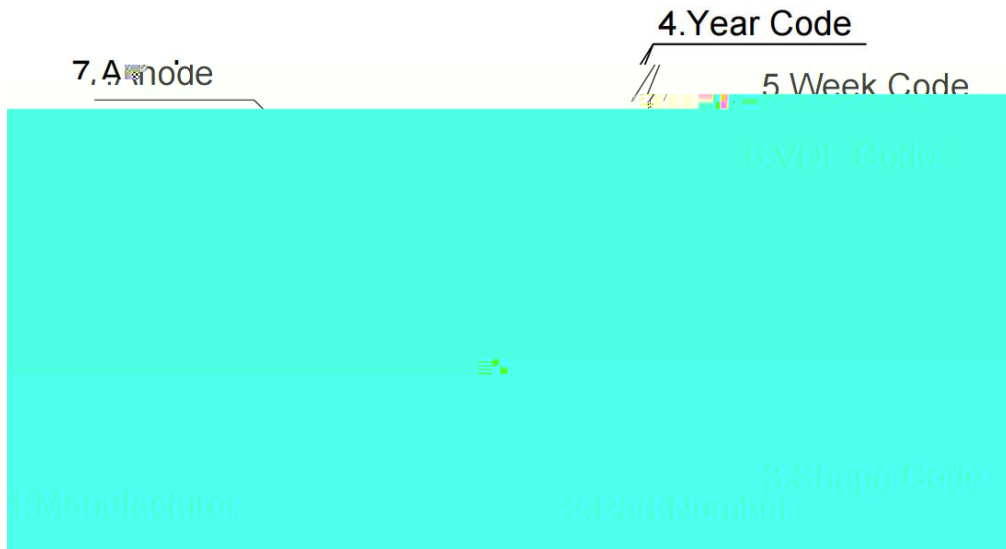

"  
,

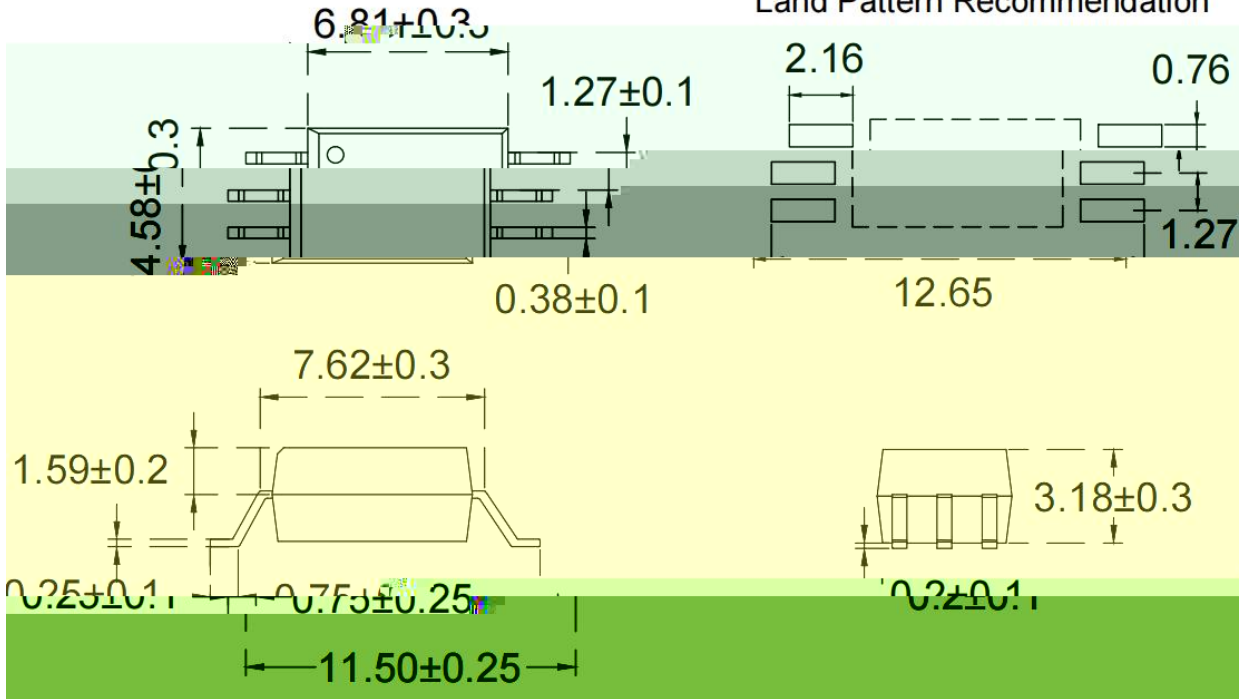

Land Pattern Recommendation

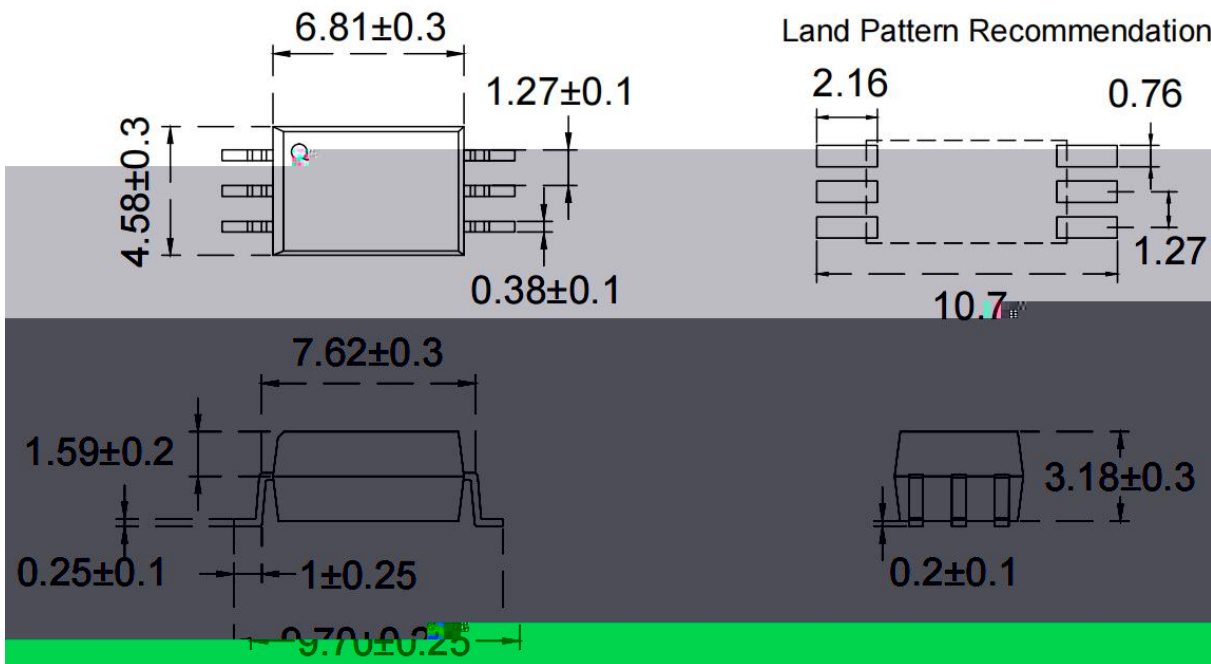

Land Pattern Recommendation



%"

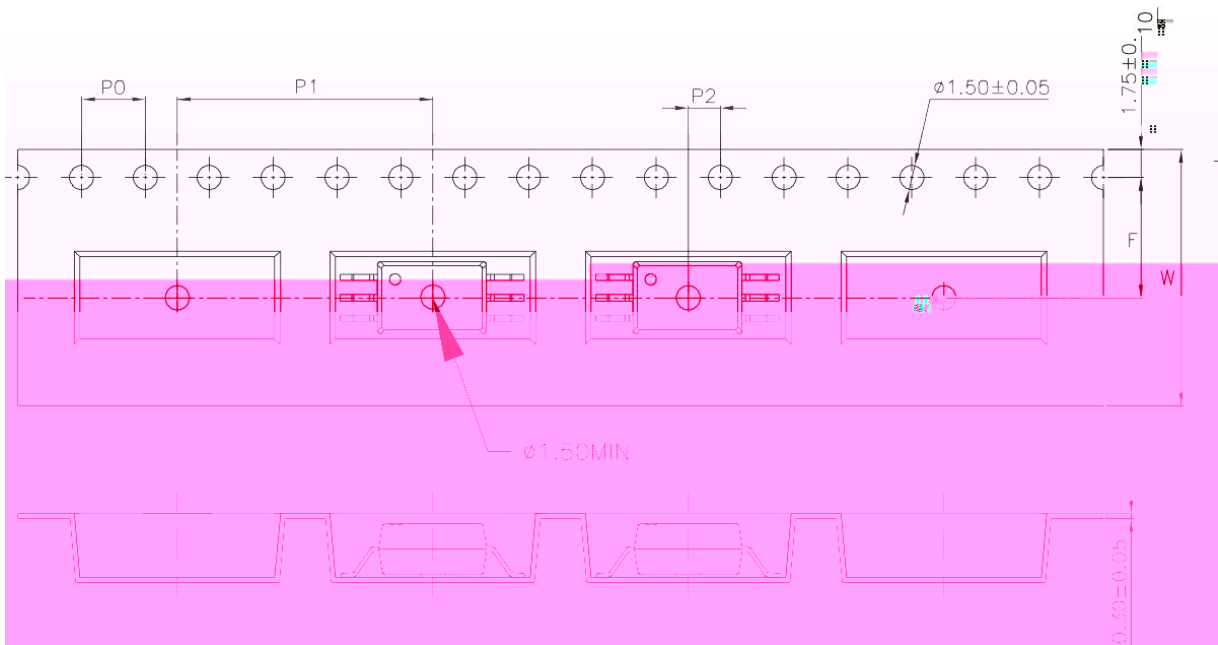
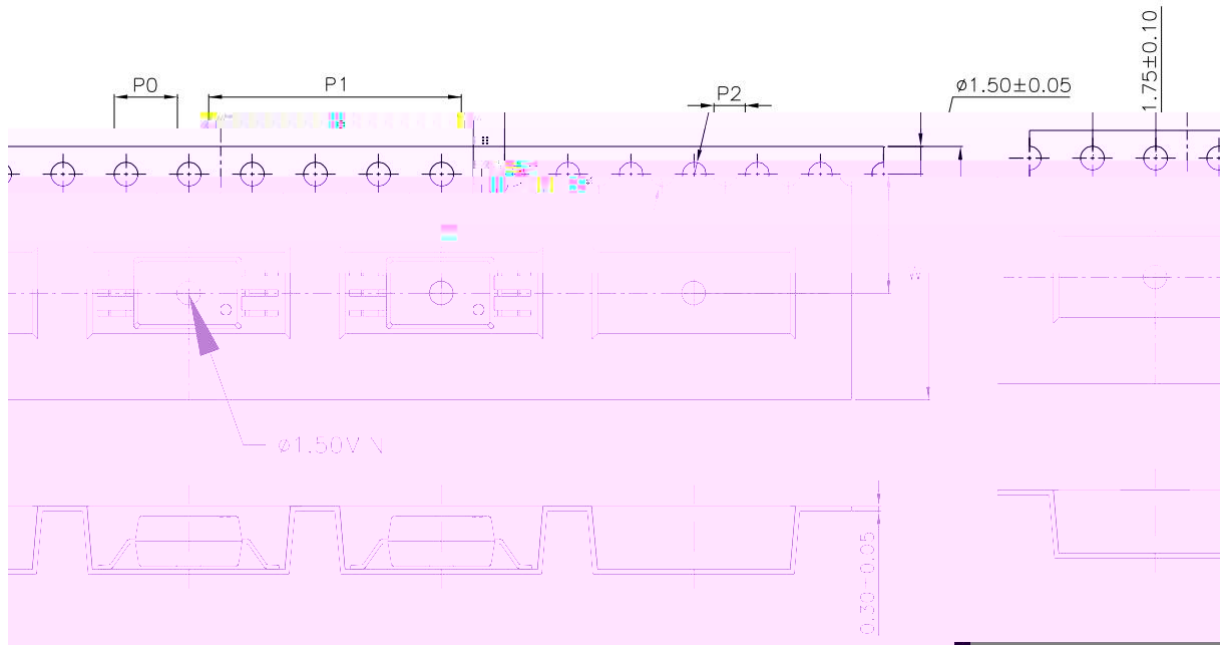



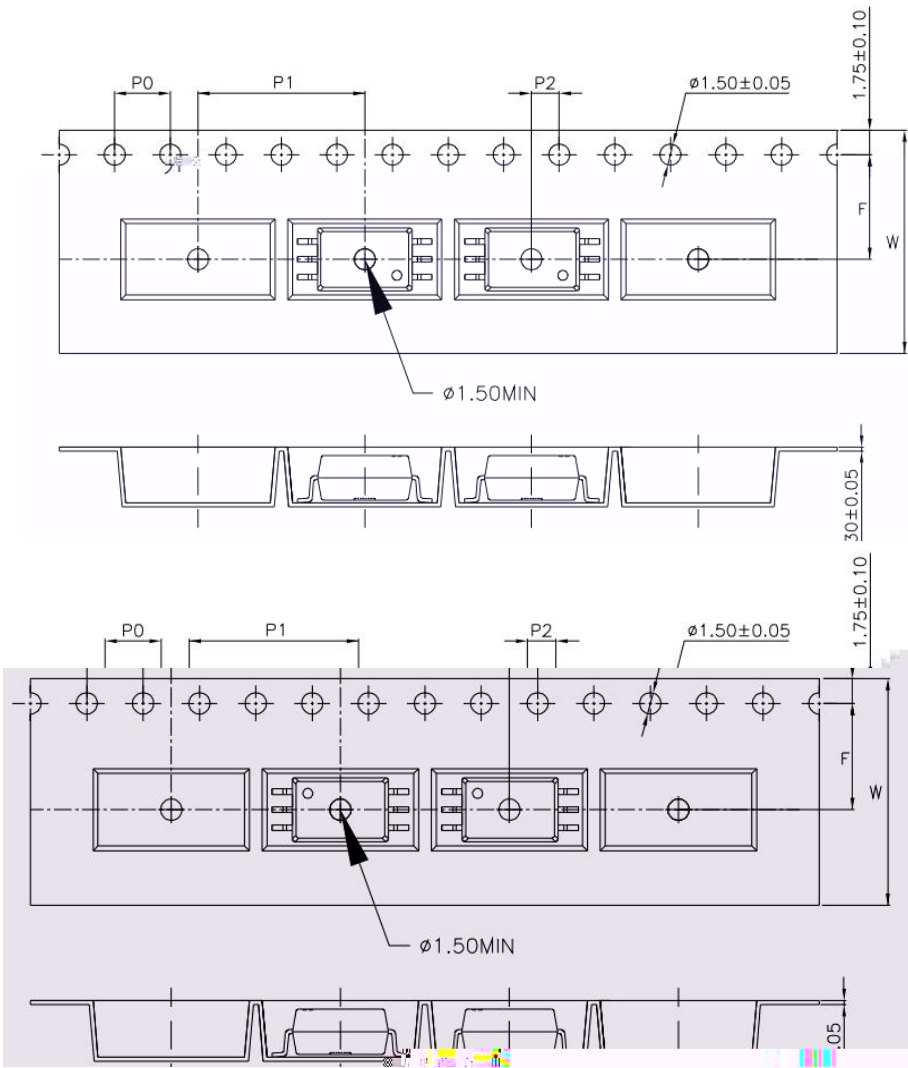





%%"  
%%"

Shenzhen Orient  
Components Co.,LTD

Material Code : 120PCXXXXX

|||||

P/N : OR-XXXXX

|||||

Lot No. : XXXXXX-XXXXX-TX-X

|||||

D/C : XXXX

|||||

Qty : XXXX PCS

|||||

内箱码

外箱码

“XXXXXXXXXXXXXXXX” (一体机序列码)

**Made in China**



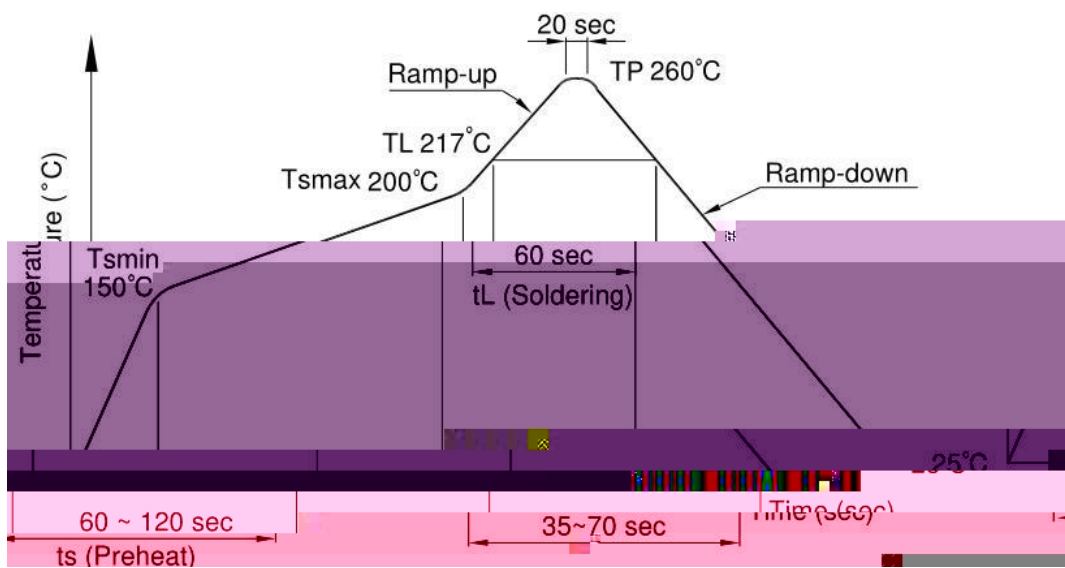

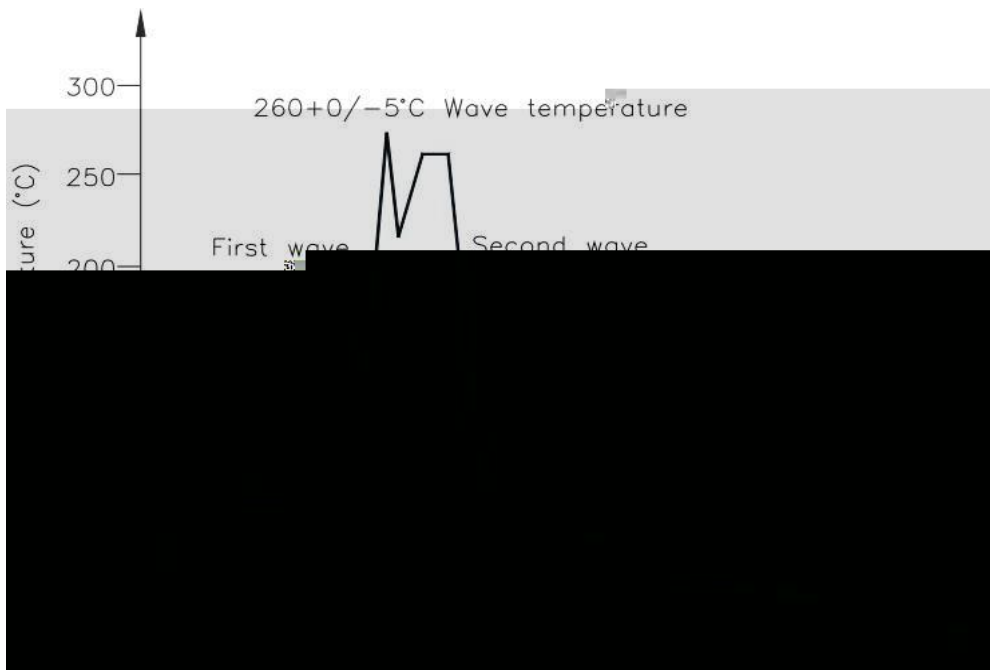

Temperature	380+0/-5°C
Time	3 sec max

%"

MAXIMUM FORWARD CURRENT vs. AMBIENT TEMPERATURE

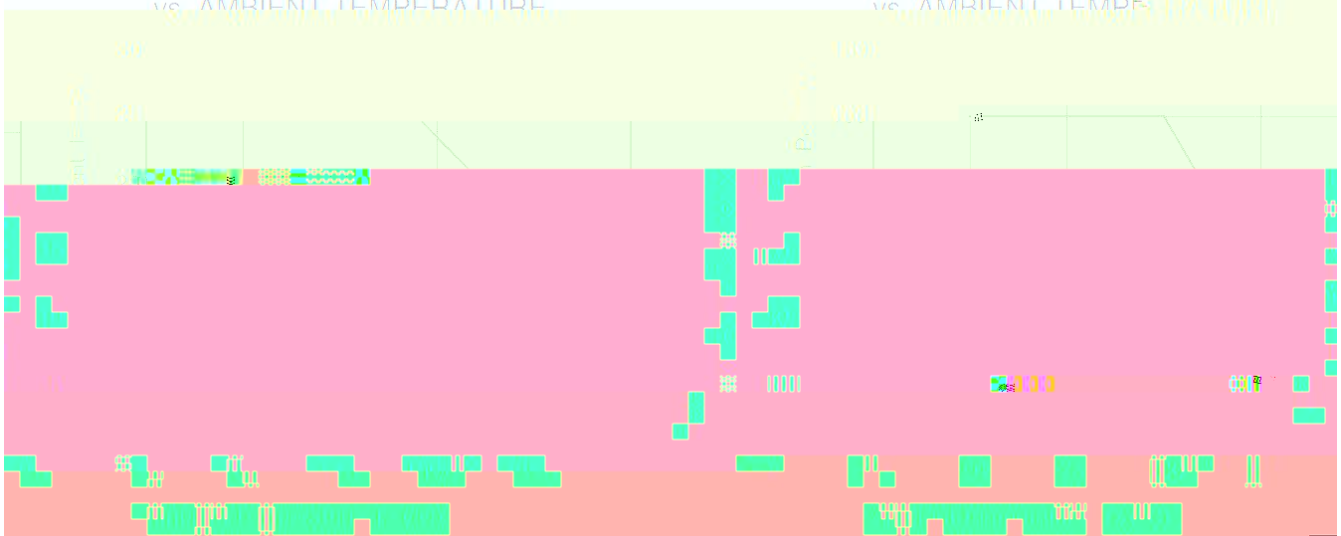
DETECTOR POWER DISSIPATION vs. AMBIENT TEMPERATURE



FORWARD CURRENT vs. FORWARD VOLTAGE

OUTPUT CURRENT vs. OUTPUT VOLTAGE



CURRENT TRANSFER RATIO vs. FORWARD CURRENT

NORMALIZED CURRENT TRANSFER RATIO vs. AMBIENT TEMPERATURE

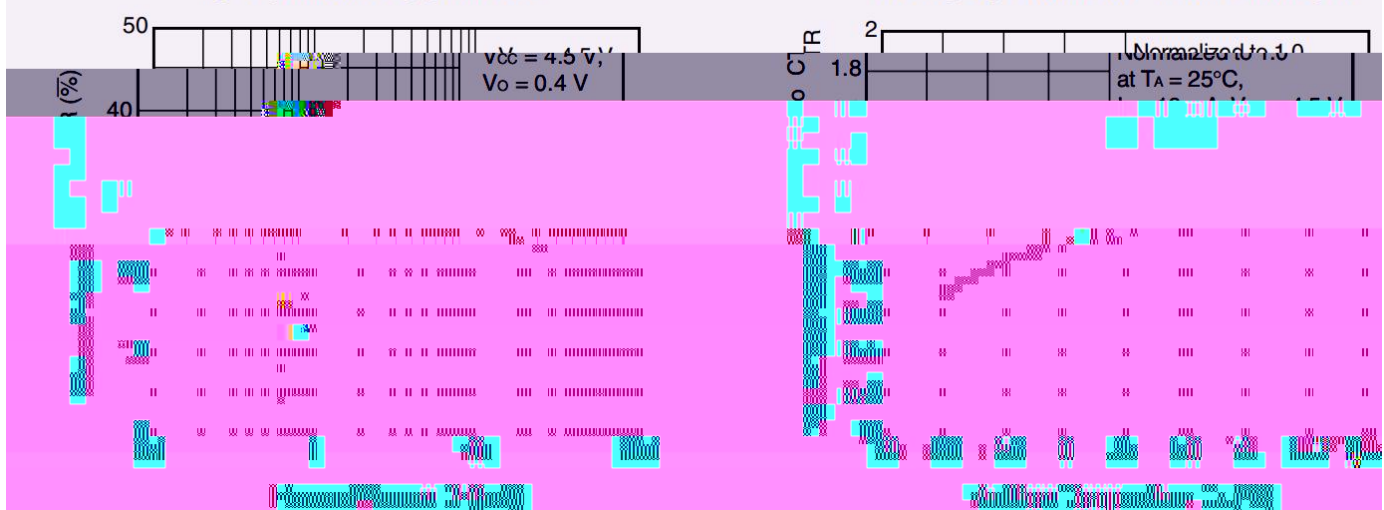

OUTPUT VOLTAGE vs. FORWARD CURRENT

HIGH LEVEL OUTPUT CURRENT vs. AMBIENT TEMPERATURE



PROPAGATION DELAY TIME vs. LOAD RESISTANCE

PROPAGATION DELAY TIME vs. AMBIENT TEMPERATURE



Test circuit for propagation delay time

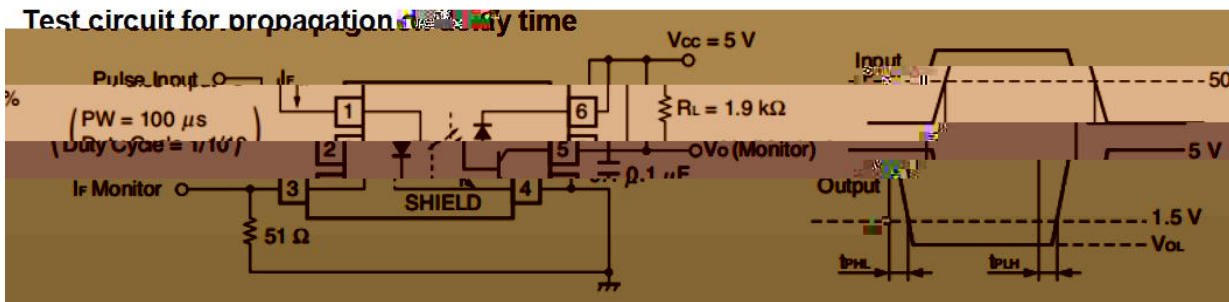

Test circuit for common mode transient immunity

